

## Spectra Glaze® 2" Shape Chart

### Stretchers and Jambs

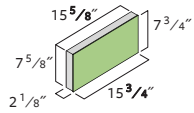

2S

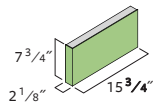

2JP

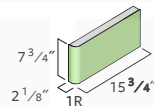

2JO

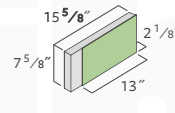

2JX

### Coves

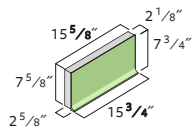

2G

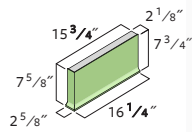

2GJPR

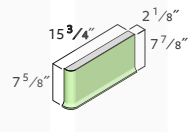

2GJOR

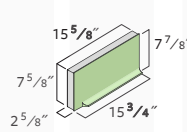

2GDR

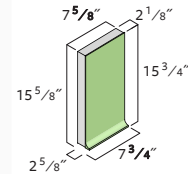

2VG



2GJPL



2GJOL



2GDL

### Caps

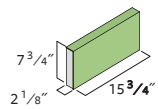

2CP

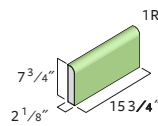

2CO

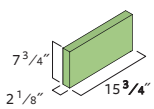

2CJPR

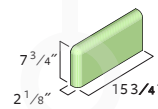

2CJOR2



2CJPL



2CJOL

### 4" High Coves (Available in 5" and 6" heights as well)

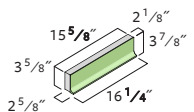

2CP

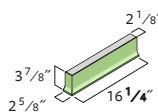

2CO

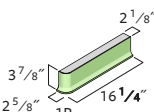

2CJPR



2CJPL



2CJOL

LAYOUT AT CORNER MUST ACCOUNT FOR THE FACT THAT THE JAMB BLOCK CORNER ANGLE VARIES FROM 91-93 DEGREES.

## Spectra Glaze® 4" Shape Chart

### Stretchers and Jambs

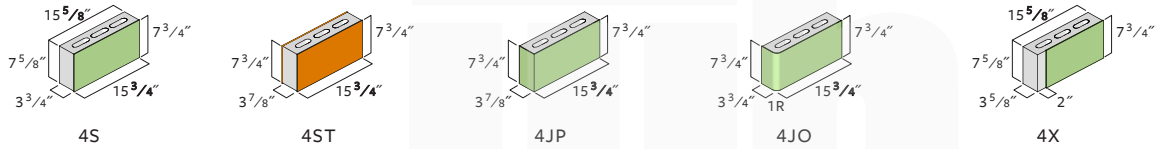

### Coves

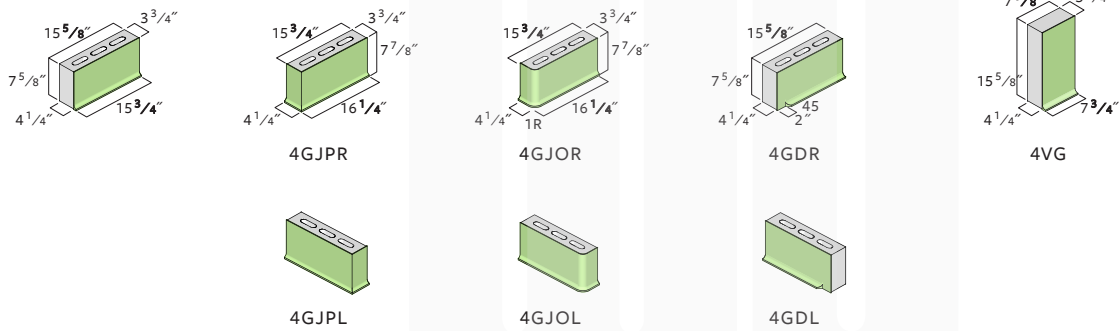

### Caps

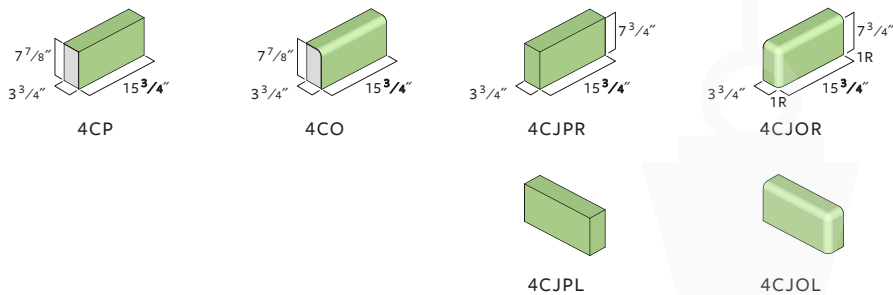

### 4" High Coves (Available in 5" and 6" as well)

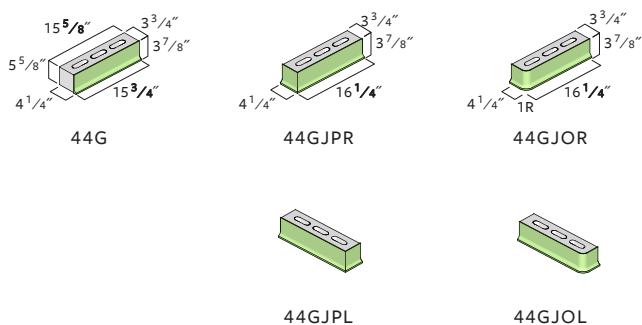

### L Corners

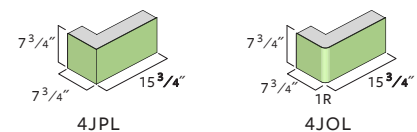

LAYOUT AT CORNER MUST ACCOUNT FOR THE FACT THAT THE JAMB BLOCK CORNER ANGLE VARIES FROM 91-93 DEGREES.

## Spectra Glaze® 6" Shape Chart

### Stretchers and Jamb

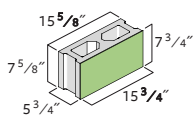

6S

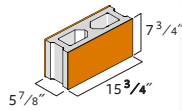

6ST

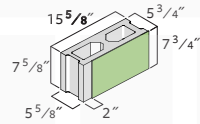

6X

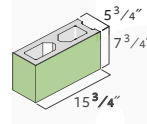

6JP

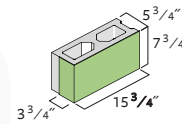

6JPX

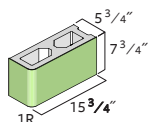

6JO

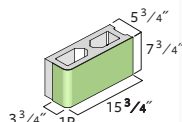

6JOX

### Coves

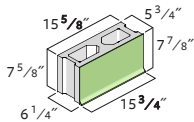

6G

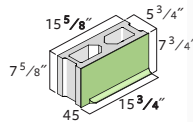

6GDR

### Lintels/Bond Beams

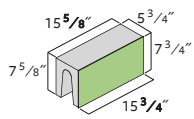

6U

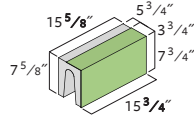

6UC

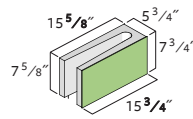

6VU

LAYOUT AT CORNER MUST ACCOUNT FOR THE FACT THAT THE JAMB BLOCK CORNER ANGLE VARIES FROM 91-93 DEGREES.

## Spectra Glaze<sup>®</sup> 8" Shape Chart

### Stretchers and Jamb

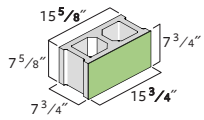

8S

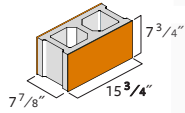

8ST

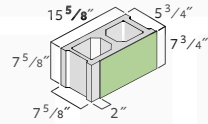

8X

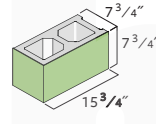

8JP

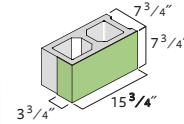

8JPX

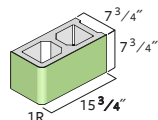

8JO

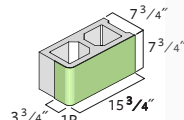

8JOX

### Coves

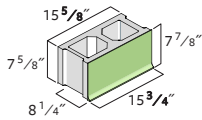

8G

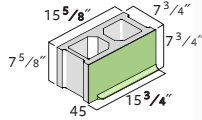

8GDR

### Lintels/Bond Beams

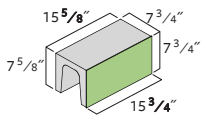

8U

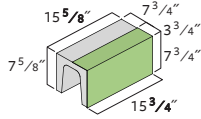

8UC

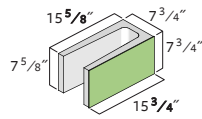

8VU

LAYOUT AT CORNER MUST ACCOUNT FOR THE FACT THAT THE JAMB BLOCK CORNER ANGLE VARIES FROM 91-93 DEGREES.

## Spectra Glaze® 10" Shape Chart

### Stretchers and Jambs

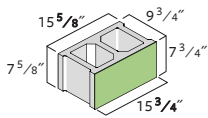

10S

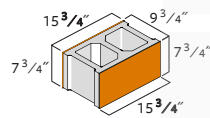

10ST

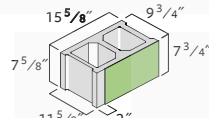

10X

### Coves

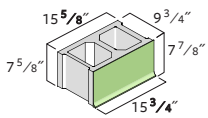

10G

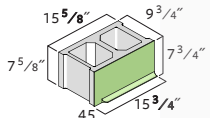

10GDR

### Lintels/Bond Beams

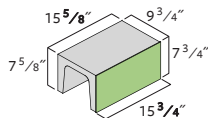

10U

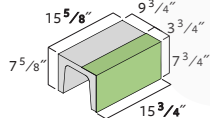

10UC

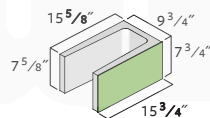

10VU

LAYOUT AT CORNER MUST ACCOUNT FOR THE FACT THAT THE JAMB BLOCK CORNER ANGLE VARIES FROM 91-93 DEGREES.

## Spectra Glaze® 12" Shape Chart

### Stretchers and Jambs

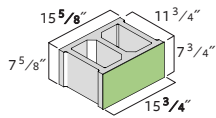

12S

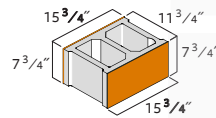

12ST

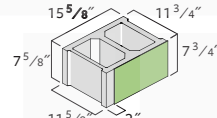

12X

### Coves

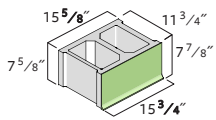

12G

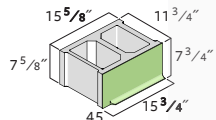

12GDR

### Lintels/Bond Beams

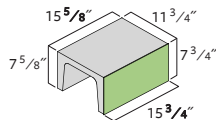

12U

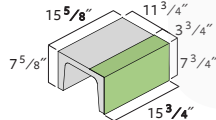

12UC

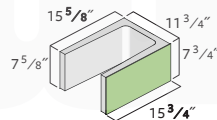

12VU

LAYOUT AT CORNER MUST ACCOUNT FOR THE FACT THAT THE JAMB BLOCK CORNER ANGLE VARIES FROM 91-93 DEGREES.

## Spectra Glaze® Trym-Saver Series Shape Chart

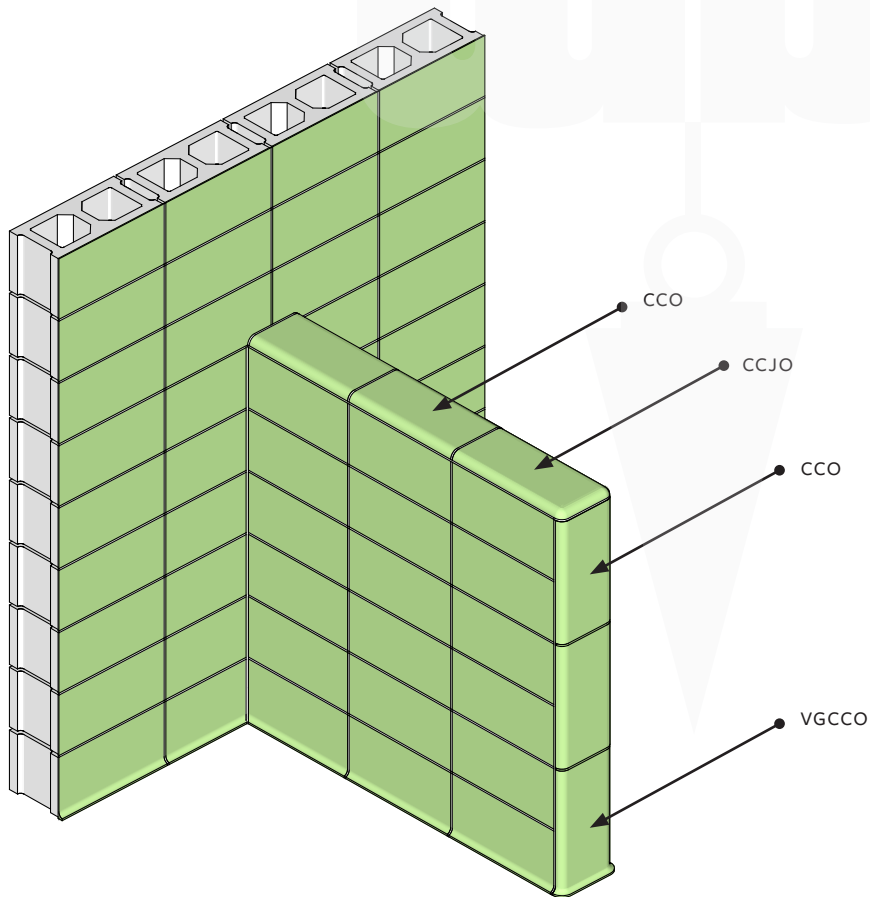
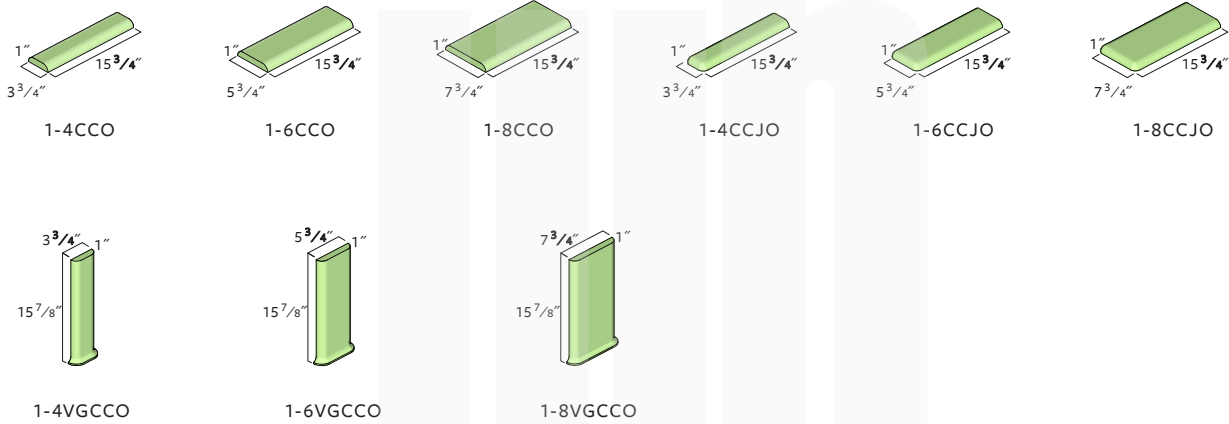

LAYOUT AT CORNER MUST ACCOUNT FOR THE FACT THAT THE JAMB BLOCK CORNER ANGLE VARIES FROM 91-93 DEGREES.